

# *Metaglas Marine*





Optionally, different window frames can be combined to create countless layouts.

Below, an impression of possible layouts.

In this documentation you will find details of different window frames.

## EXAMPLES OF DIFFERENT LAYOUTS

vertical sliding windows



horizontal sliding windows

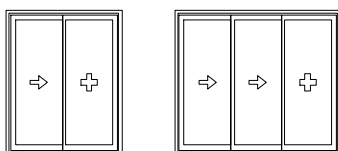

fixed windows

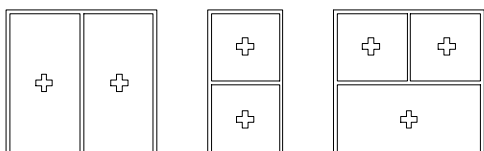

automatic horizontal sliding windows

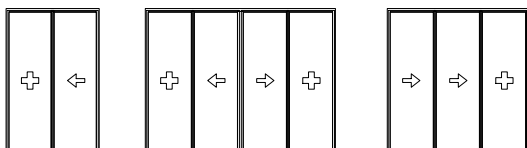

# METAGLAS XL MARINE

Metaglas XL vertical sliding system, type **XEVS-10A** with sliding upper pane and fixed lower pane.

Provided with:

- Energy efficient double-glazing.
- Optionally: High energy efficient triple-glazing.

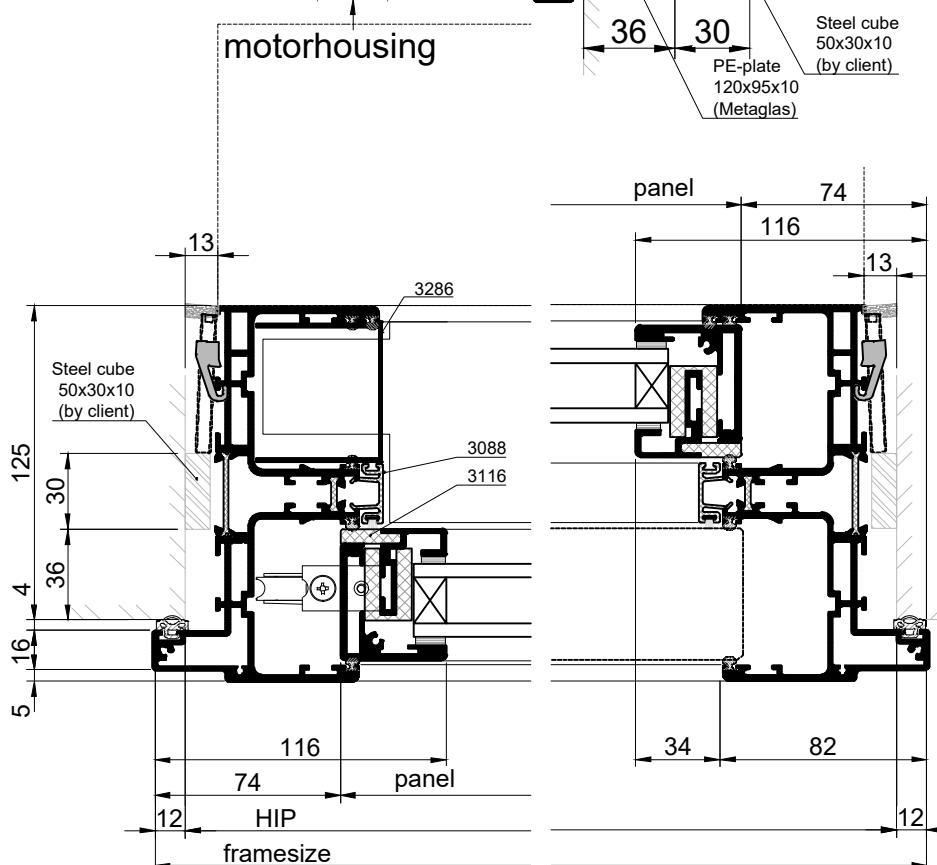
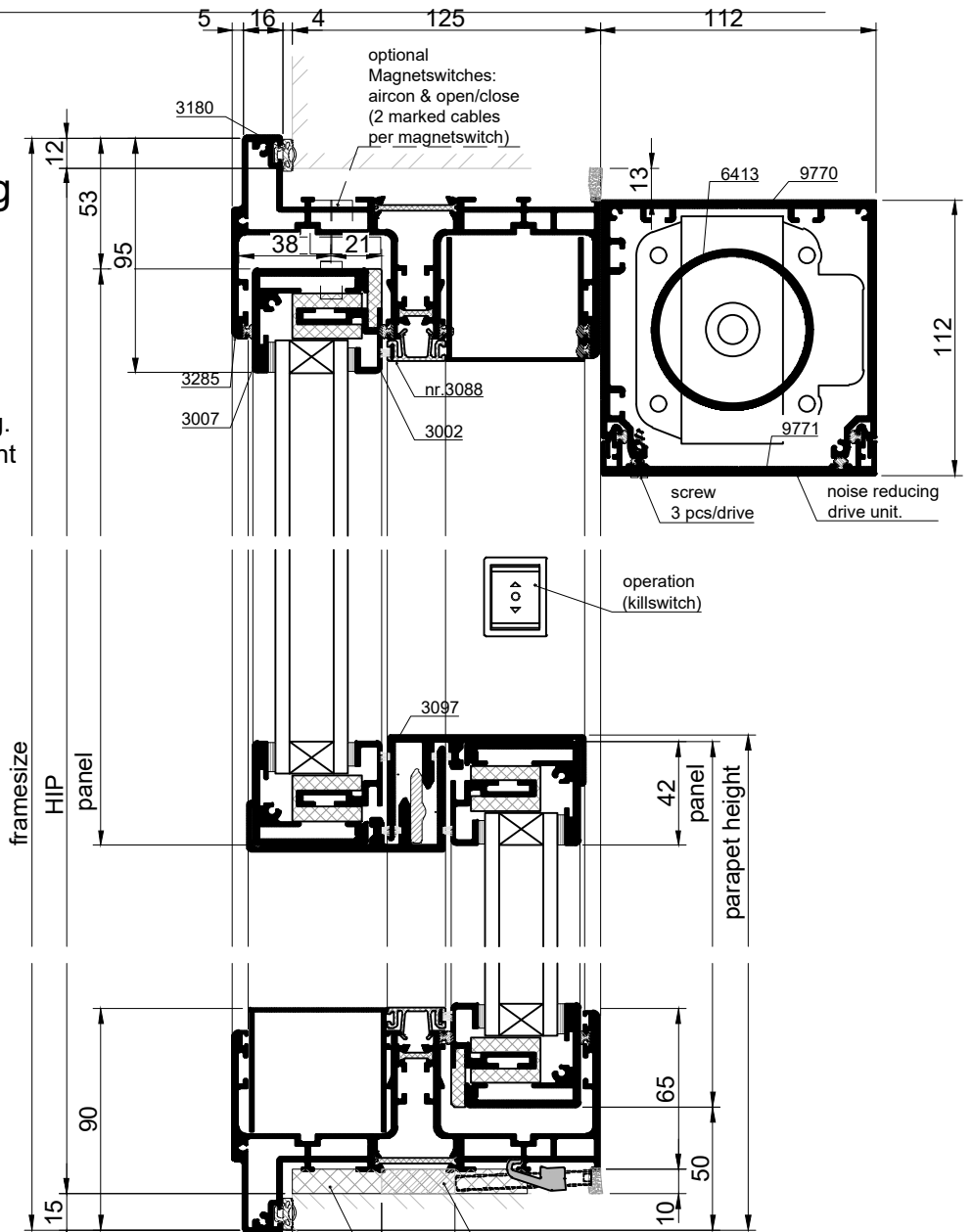
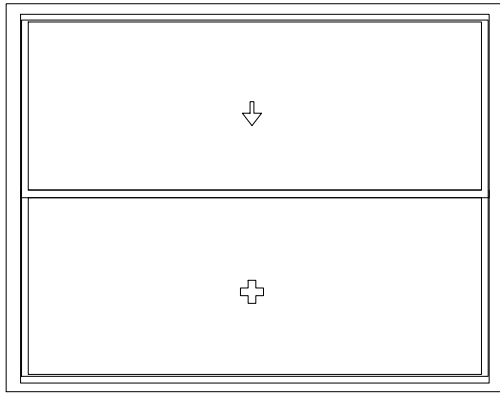

metaglas.

Het Eek 5, 4004LM Tiel, The Netherlands  
Tel.: +31 344 750400 info@metaglas.nl

Metaglas XL horizontal sliding system, type **XHS-26A** with one sliding and one fixed pane.

Provided with:

- Energy efficient double-glazing.
- Optionally: High energy efficient triple-glazing.

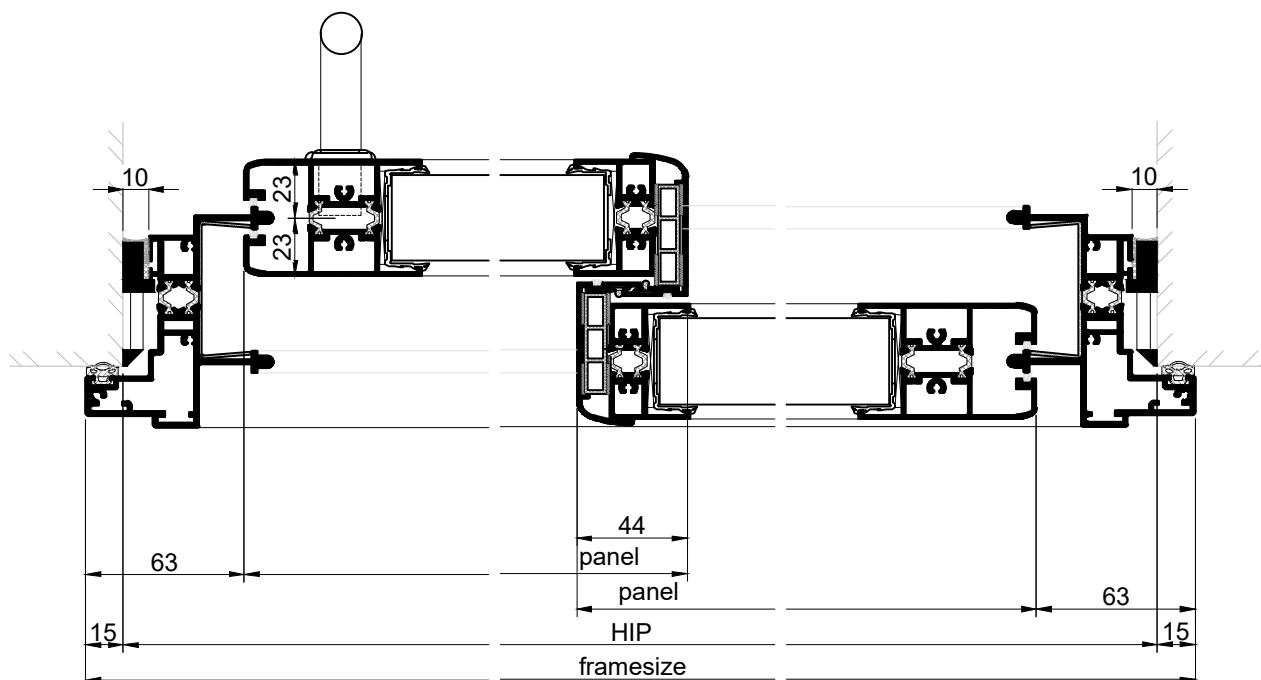
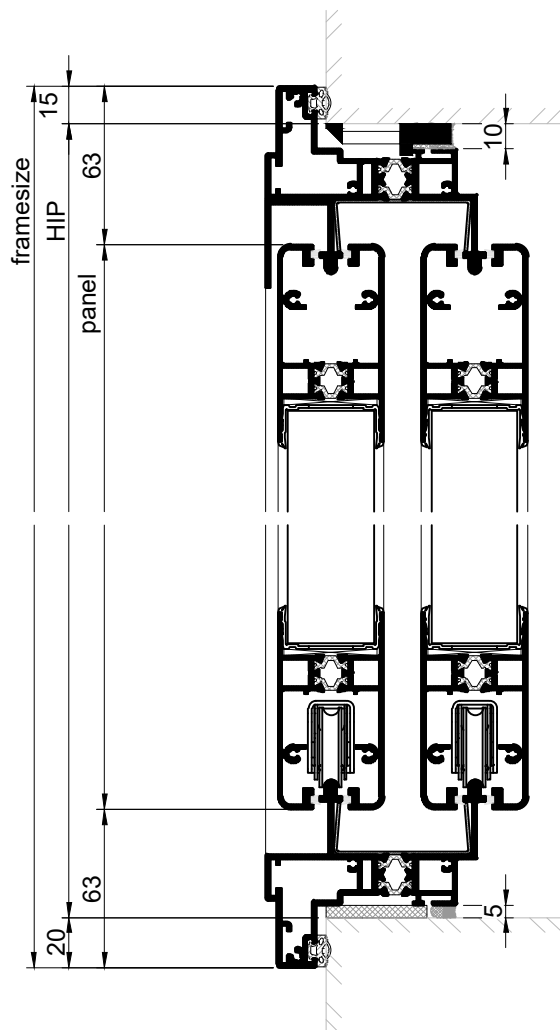
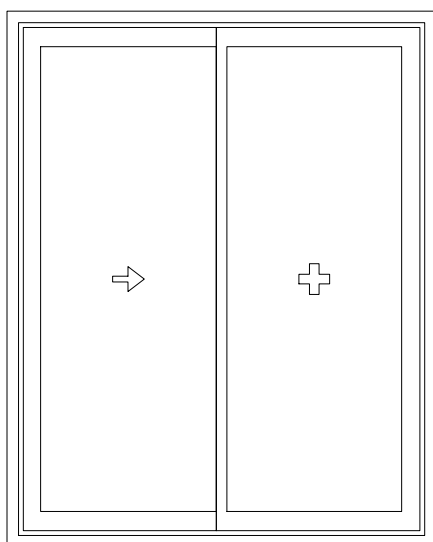

# METAGLAS XL MARINE

Metaglas XL horizontal sliding system, type **XHS-36A** with two sliding panes and one fixed pane.

Provided with:

- Energy efficient double-glazing.
- Optionally: High energy efficient triple-glazing.

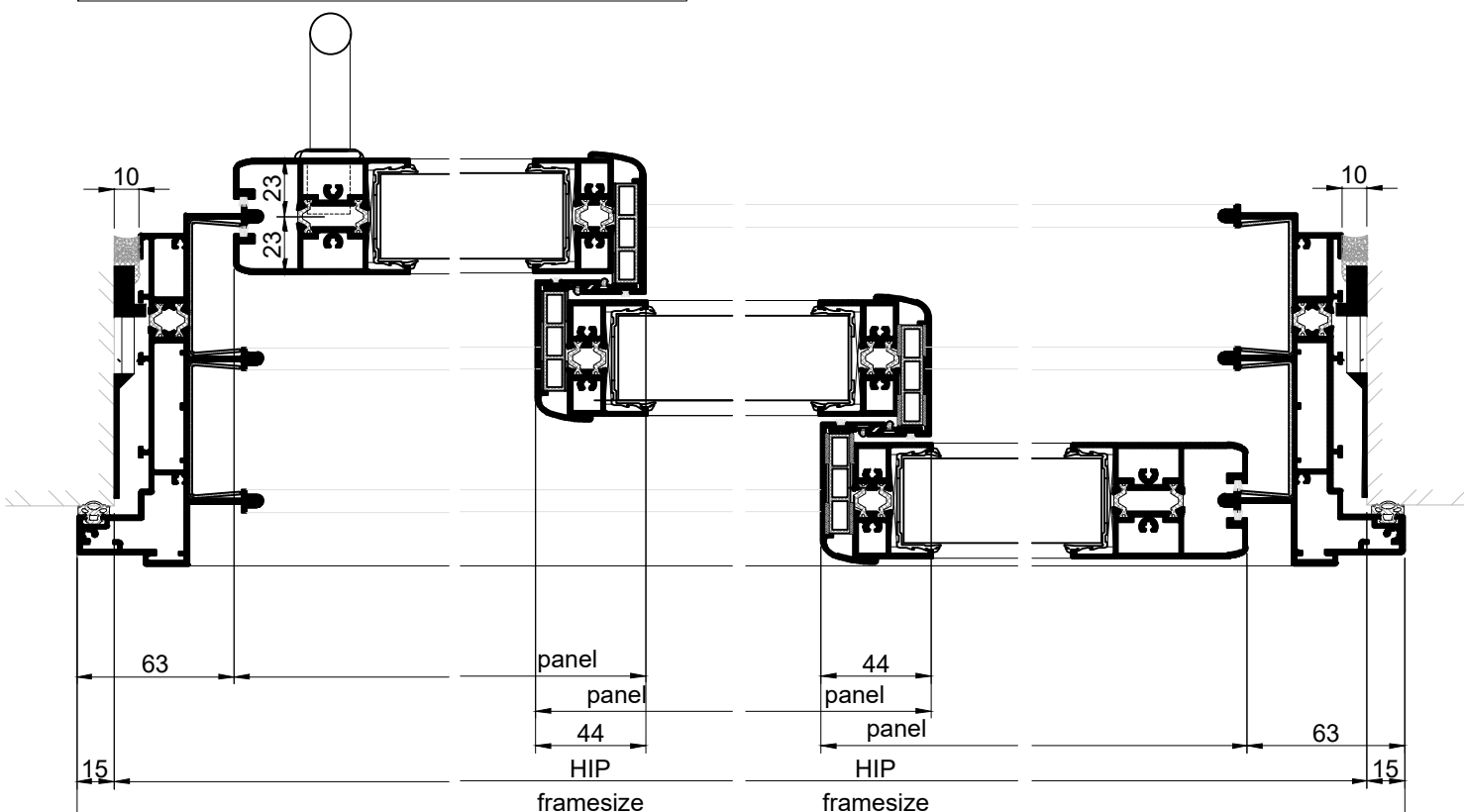
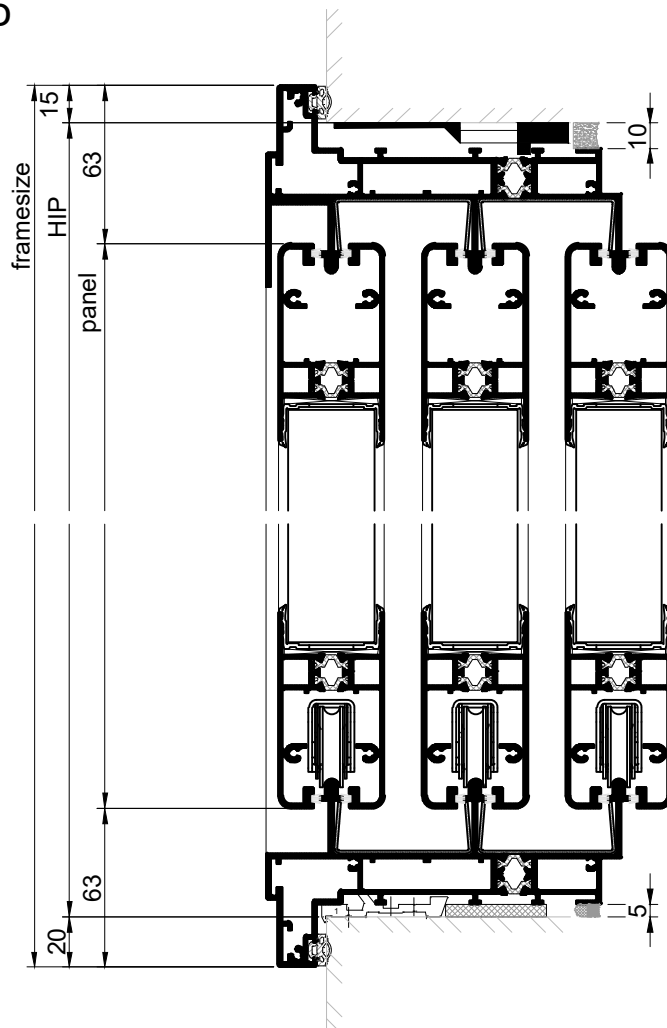
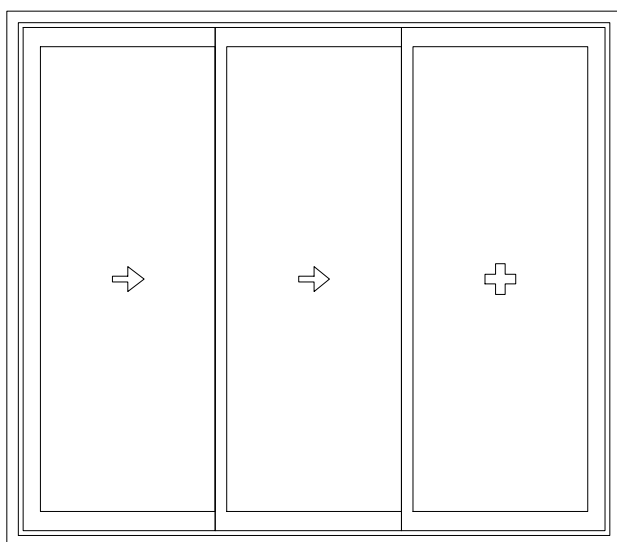

metaglas.

Het Eek 5, 4004LM Tiel, The Netherlands  
Tel.: +31 344 750400 info@metaglas.nl

Metaglas XL single-paned fixed window, type **XVI-1**.

Provided with:

- Energy efficient double-glazing.
- Optionally: High energy efficient triple-glazing.

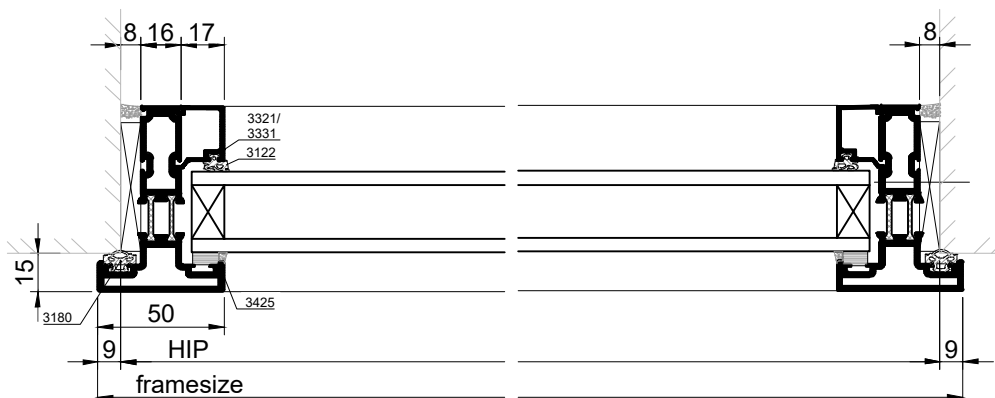
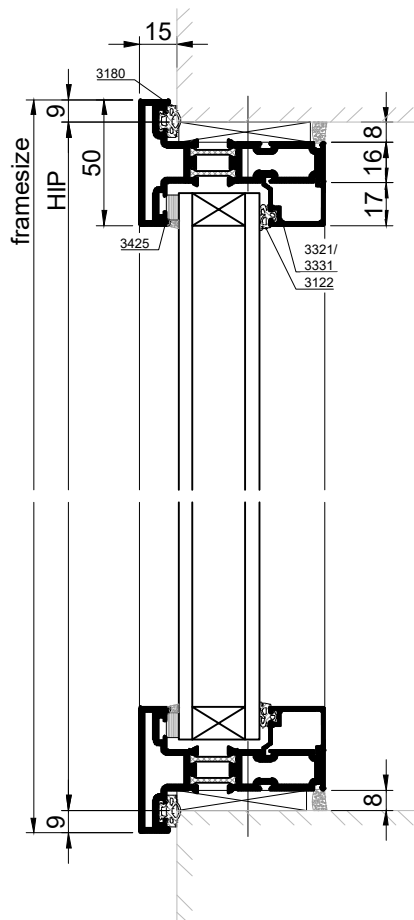
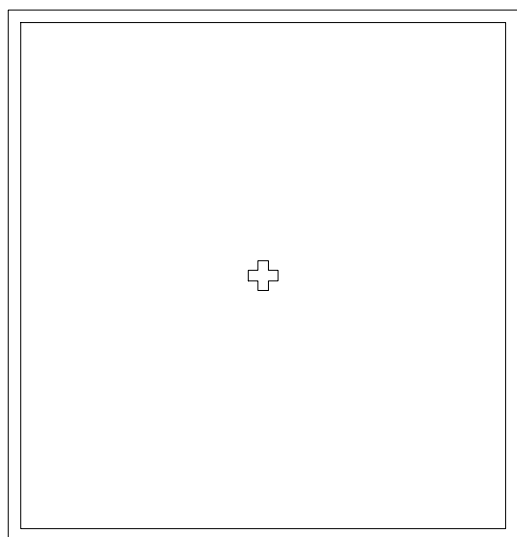

Metaglas XL single-paned fixed window, type **XVU-1**.

Provided with:

- Energy efficient double-glazing.
- Optionally: High energy efficient triple-glazing.

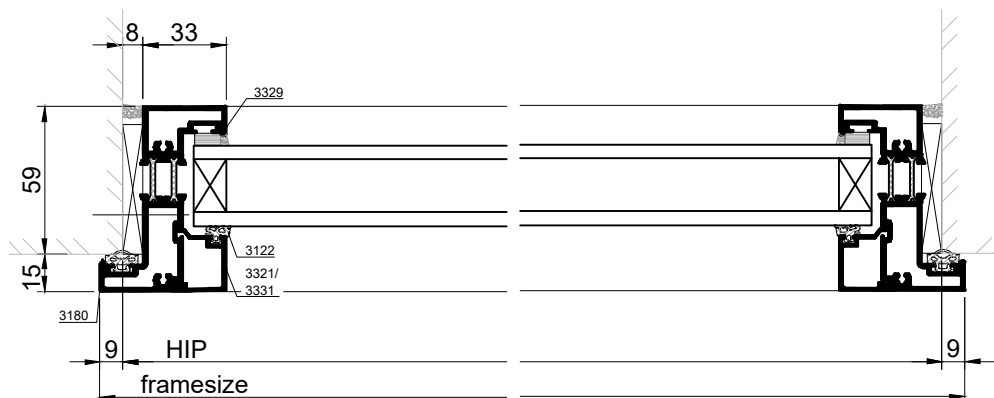
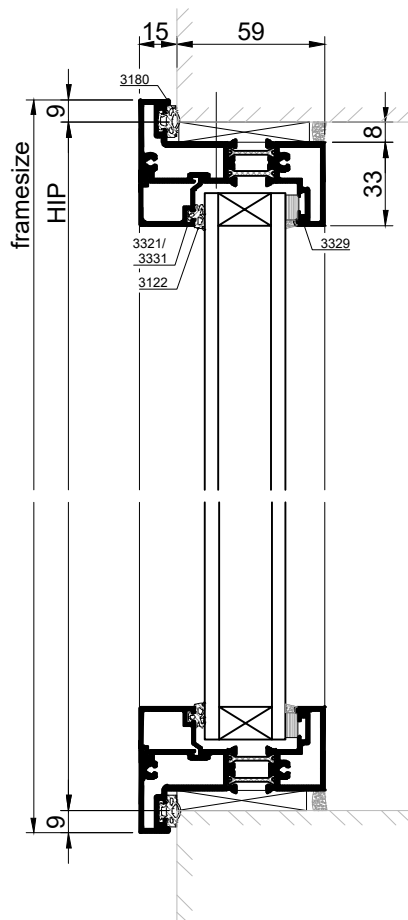
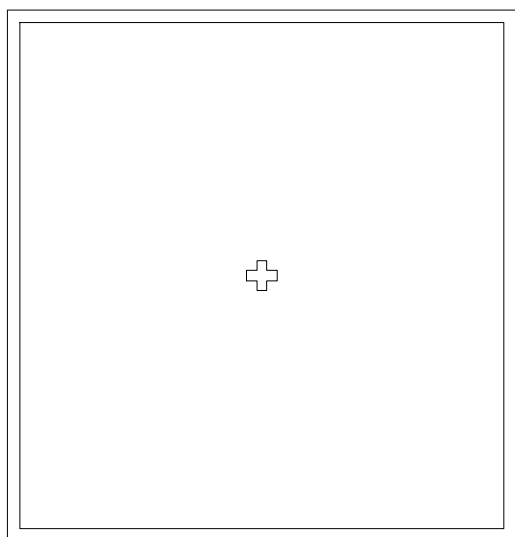

Metaglas XL multiple-paned fixed windows, type **XVU-2**.

Provided with:

- Energy efficient double-glazing.
- Optionally: High energy efficient triple-glazing.

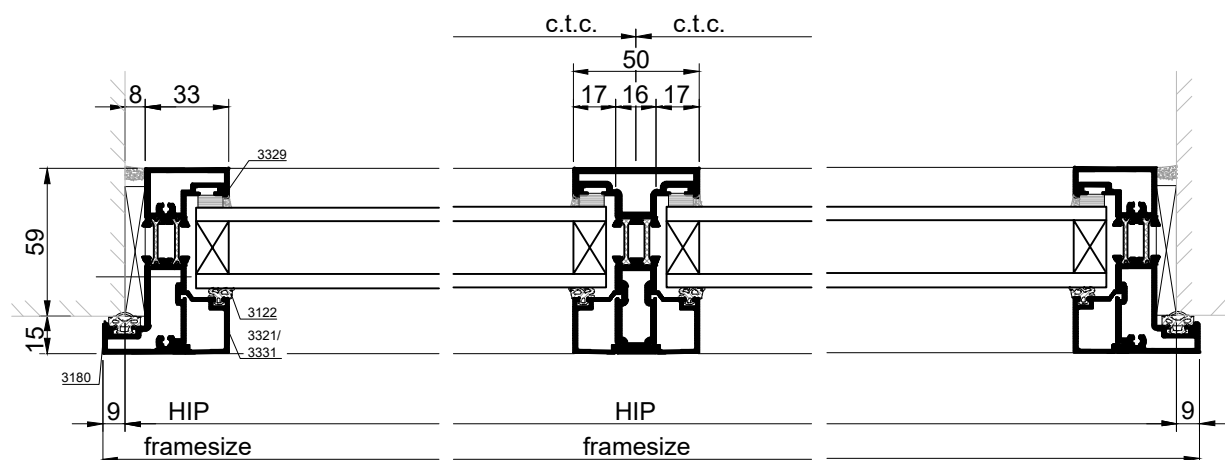
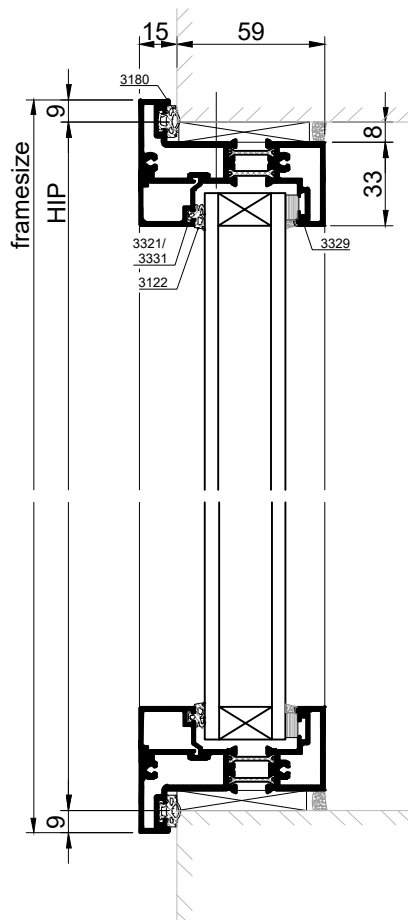
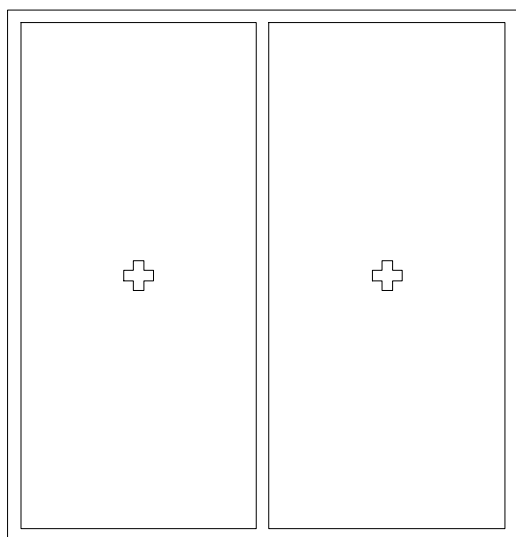

Metaglas XL multiple-paned fixed windows, type **XVU-2**.

Provided with:

- Energy efficient double-glazing.
- Optionally: High energy efficient triple-glazing.

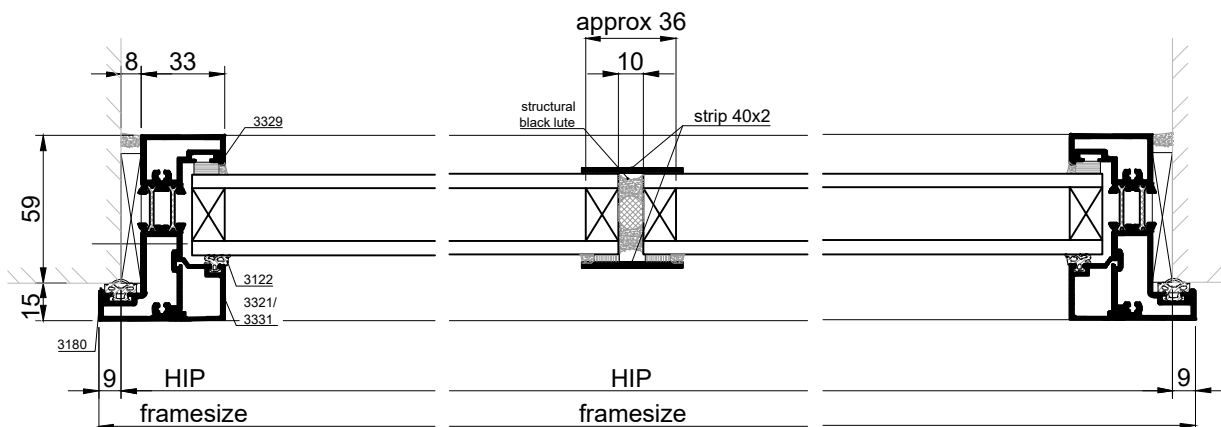
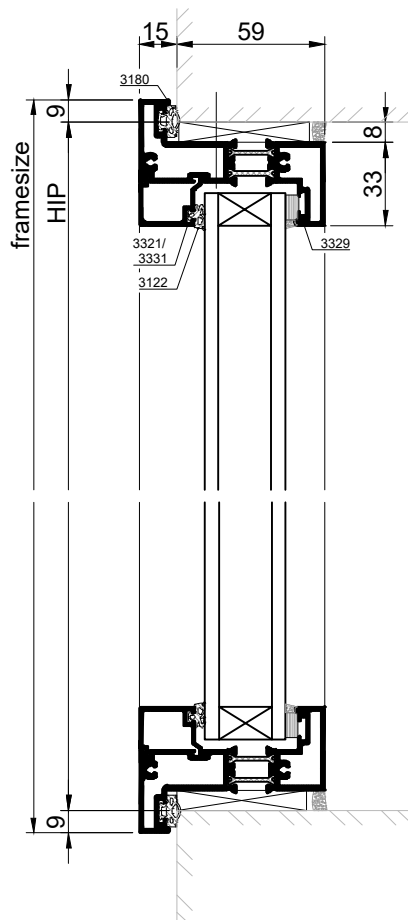
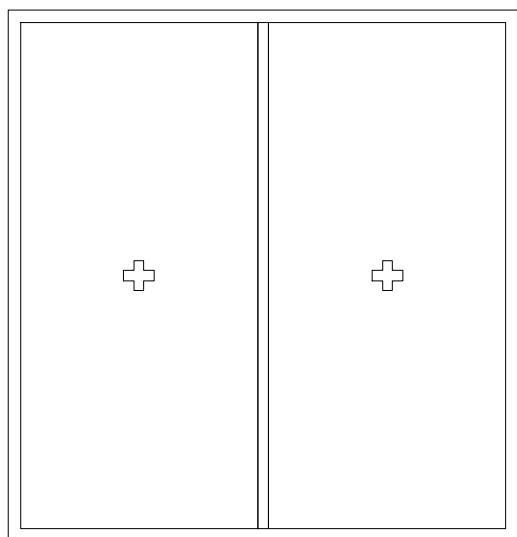

**Metaglas glued glass, type XGG-1.**

Provided with:

- Energy efficient double-glazing.

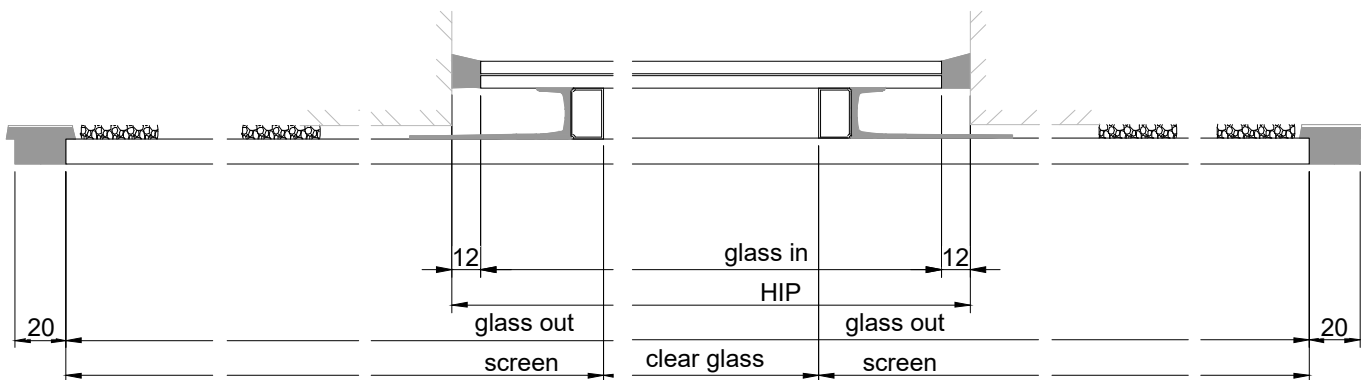
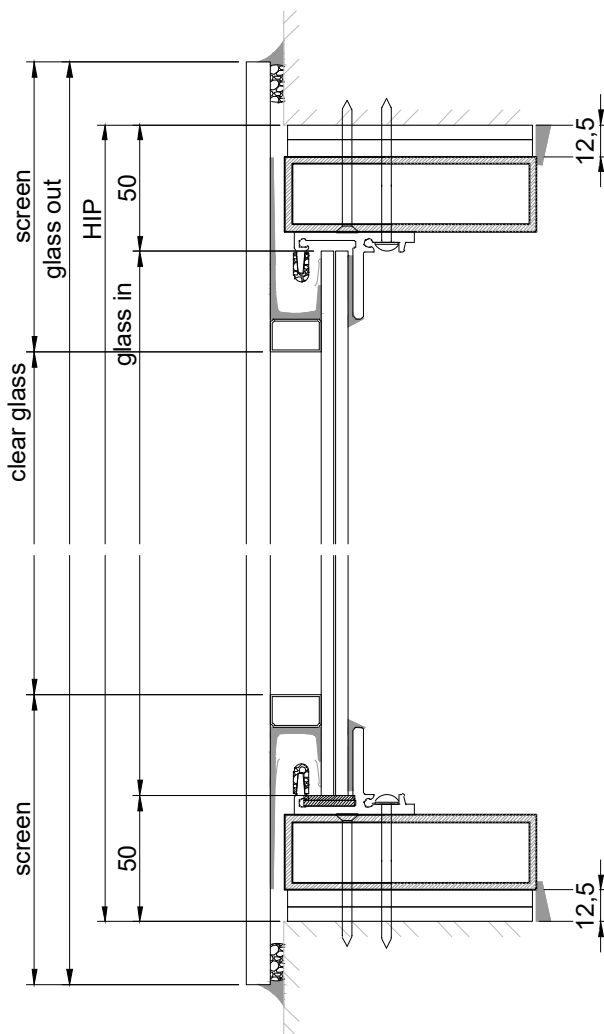
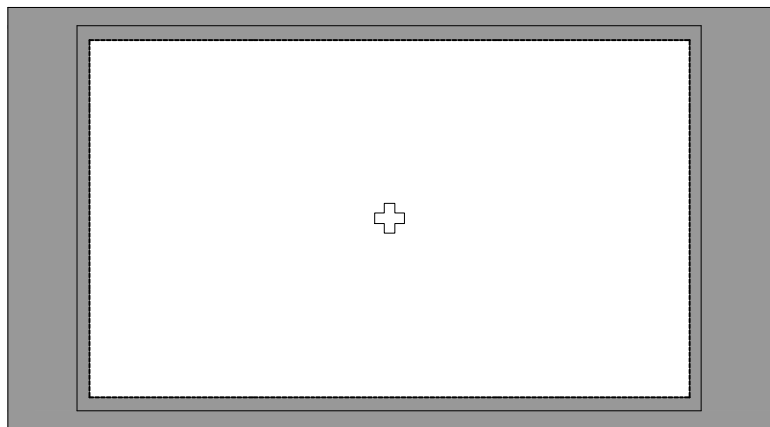

# Metaglas single skylight, type **XSL-1** (walkable)

Provided with:

- Energy efficient double-glazing.

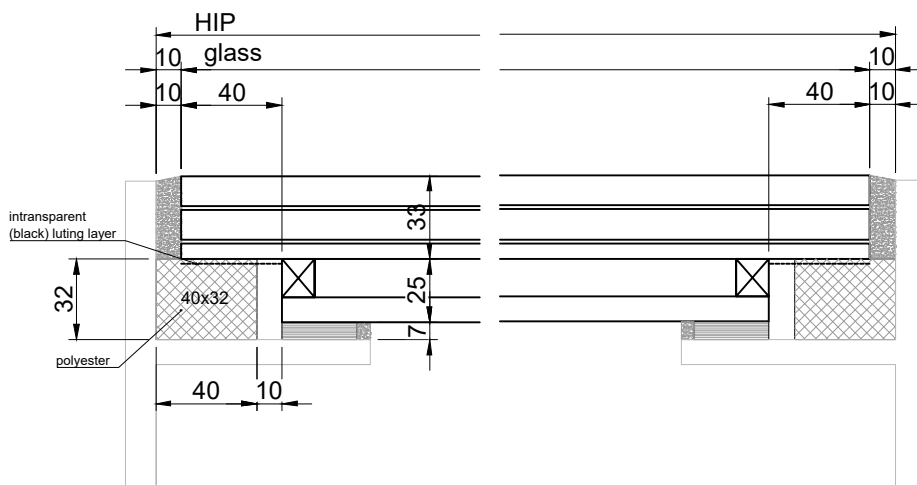
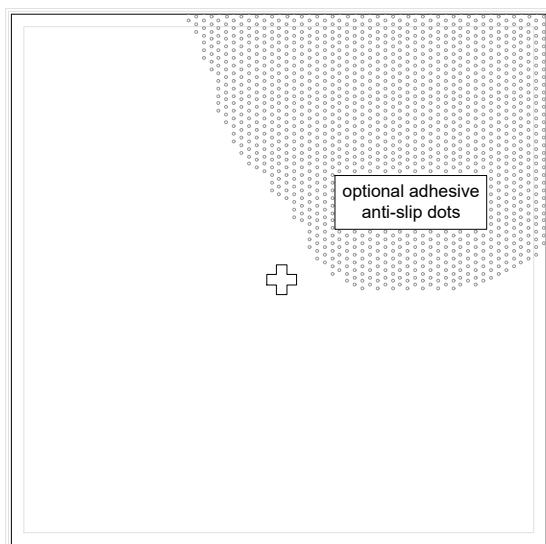

# Metaglas multiple skylights, type **XSL-2** (walkable)

Provided with:

- Energy efficient double-glazing.

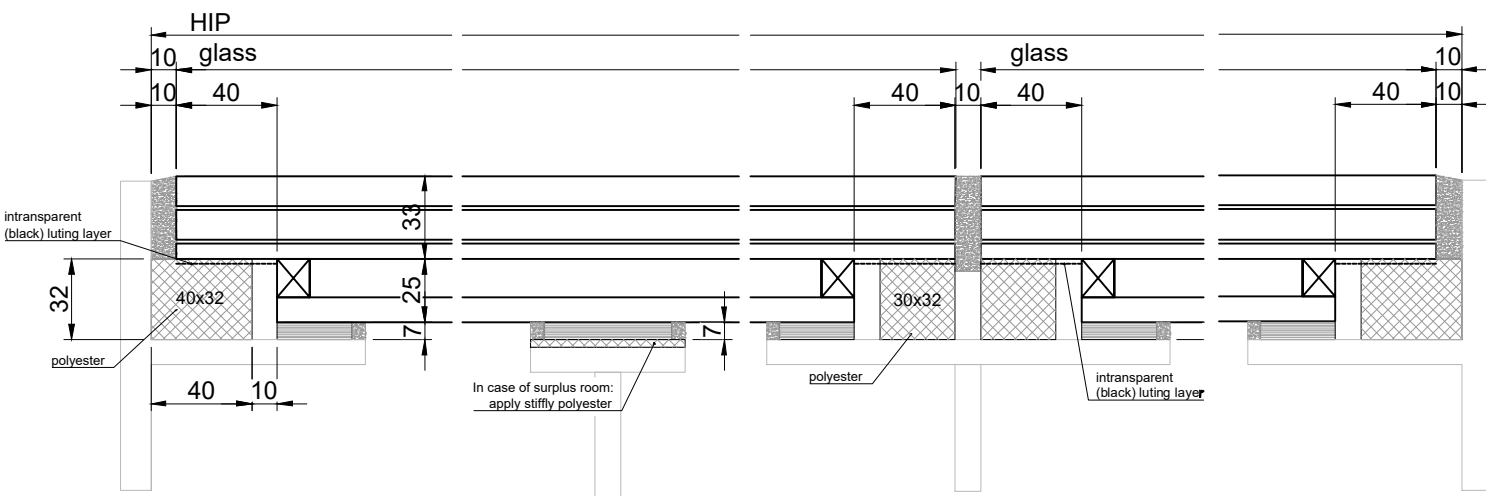
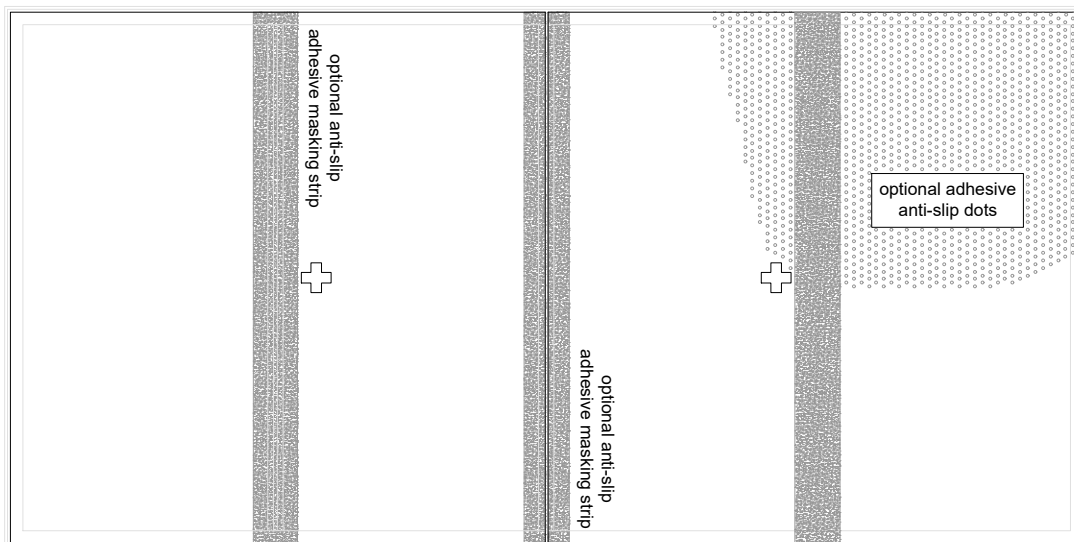

# METAGLAS XL MARINE

Metaglas XL horizontal automatic sliding system, type **XEHS-3A** with one sliding and one fixed pane.

Provided with:

- Energy efficient double-glazing.

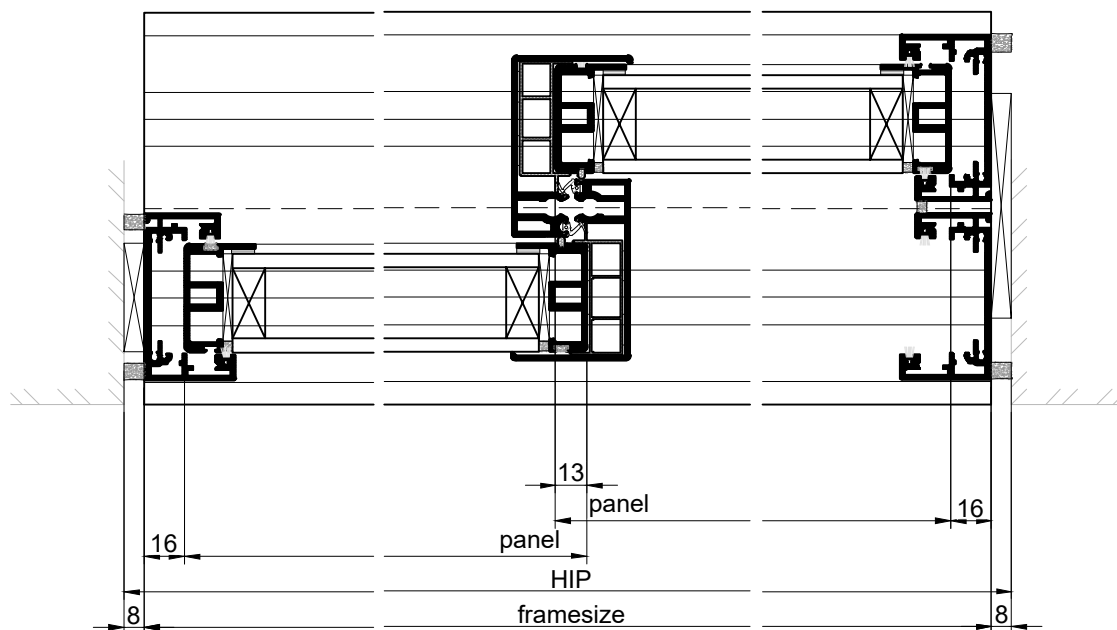
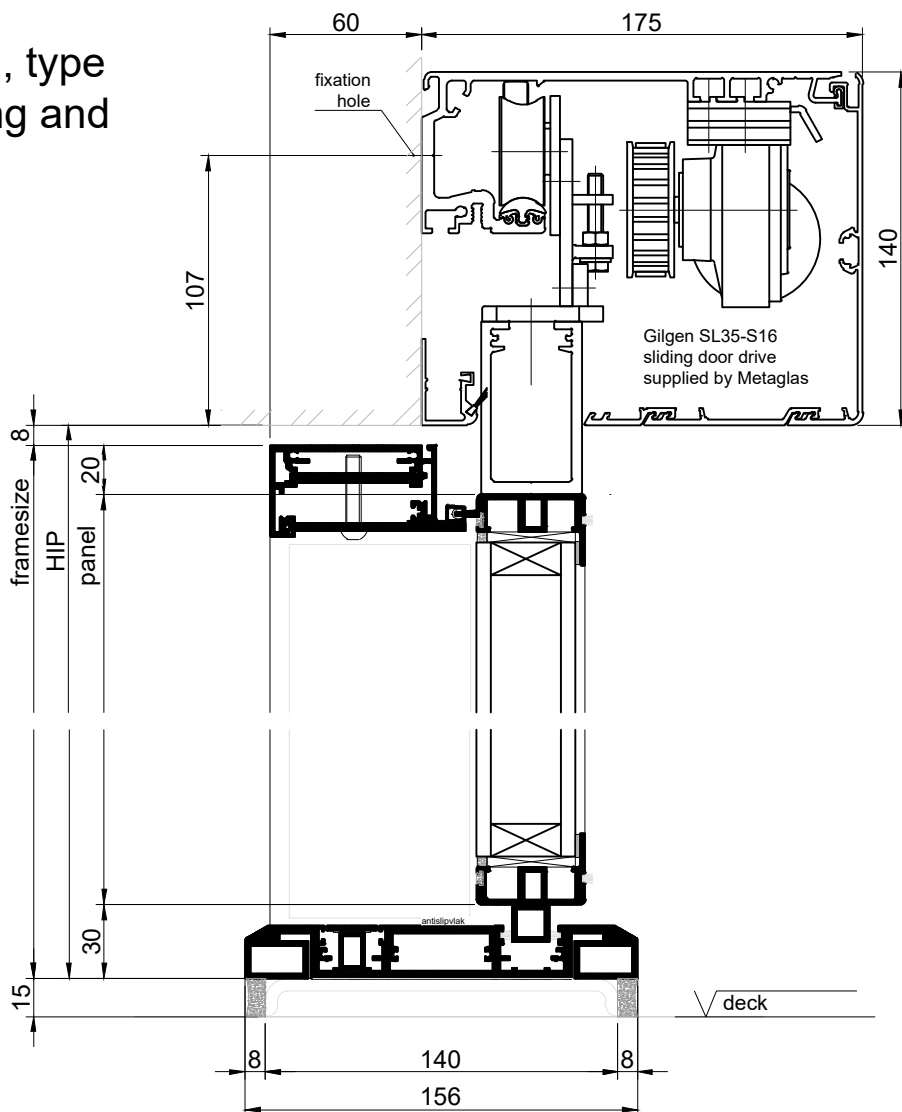
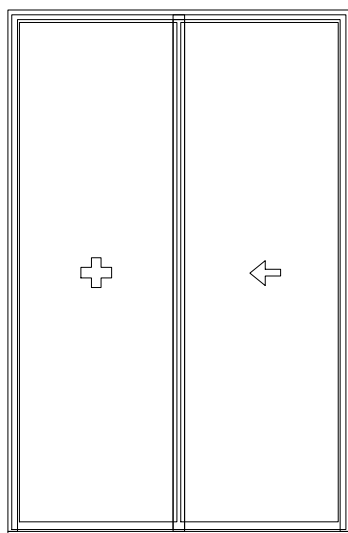



# METAGLAS XL MARINE

Metaglas XL horizontal automatic sliding system, type **XEHS-3-3A** with two sliding and one fixed pane.

Provided with:

- Energy efficient double-glazing.

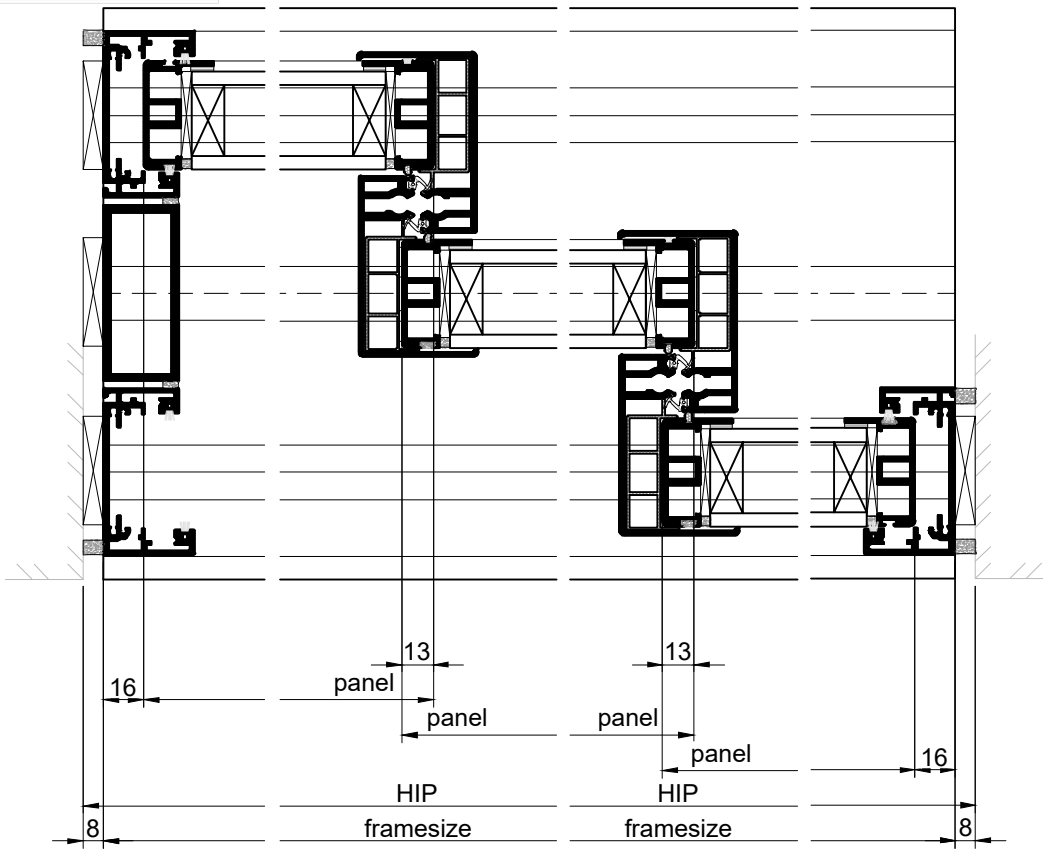
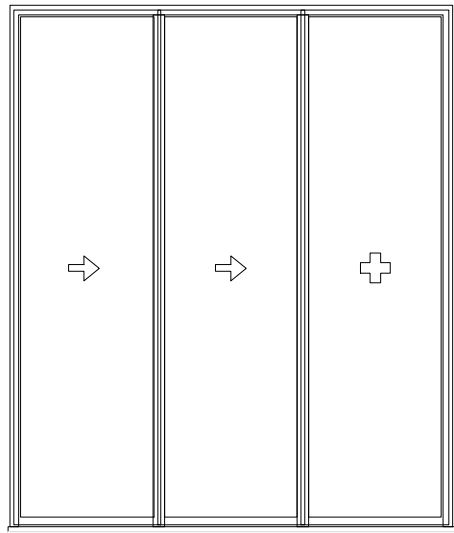
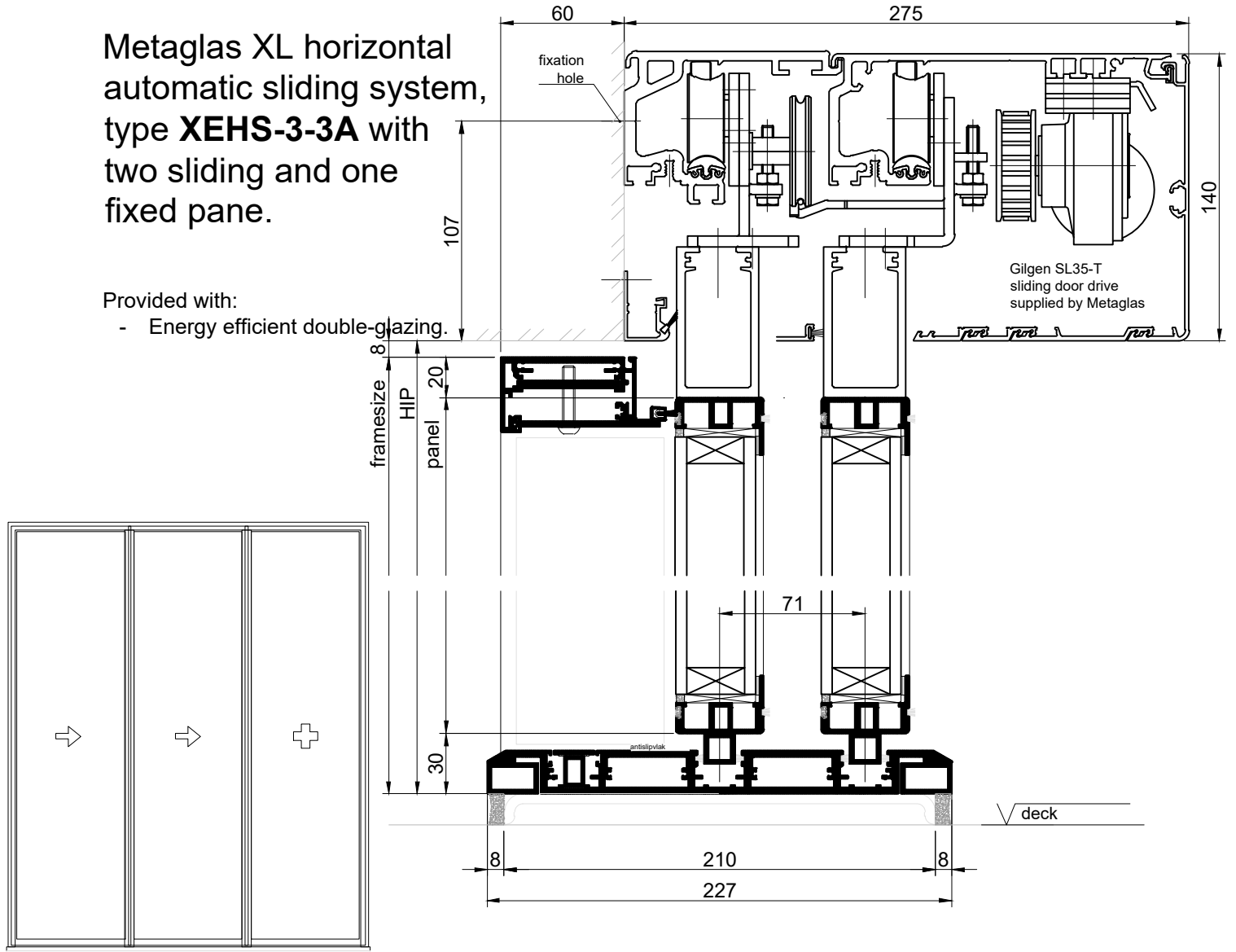

metaglas.

Het Eek 5, 4004LM Tiel, The Netherlands  
Tel.: +31 344 750400 info@metaglas.nl

Metaglas XL inward opening door, type **XID-1A**.

Provided with:

- Energy efficient double-glazing.

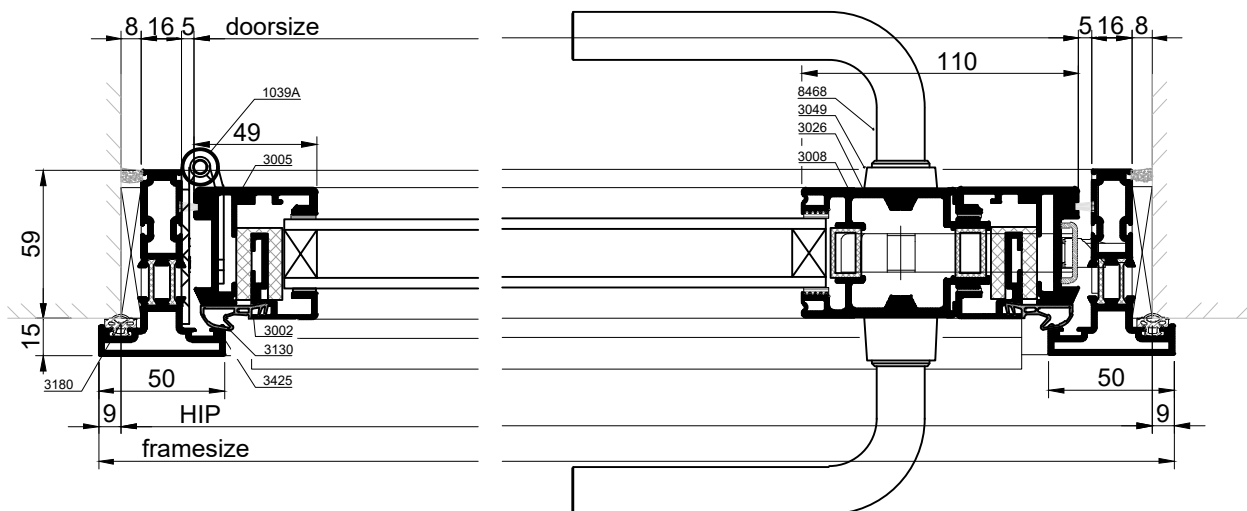
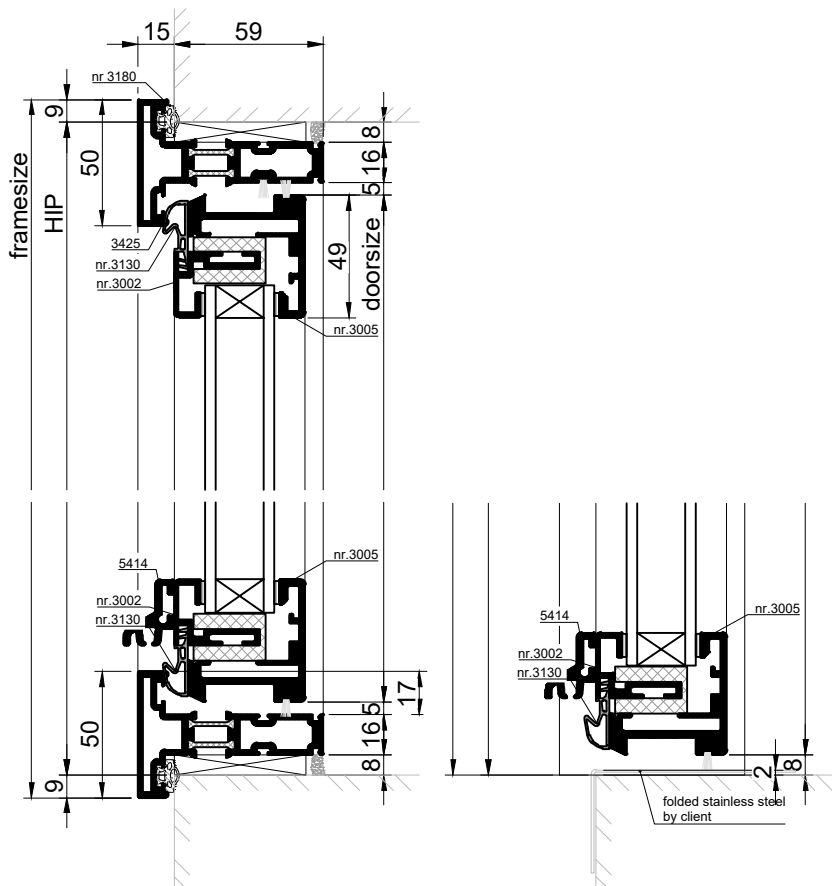
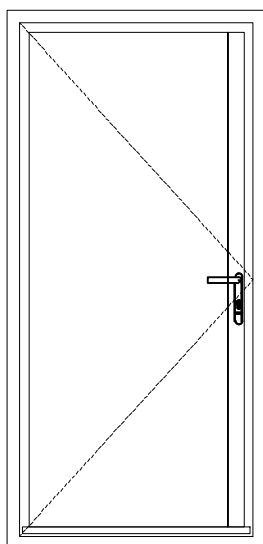

Metaglas XL inward opening blind door, type **XID-1A**.

Provided with:

- Colourcoated inner and outer aluminium plate.

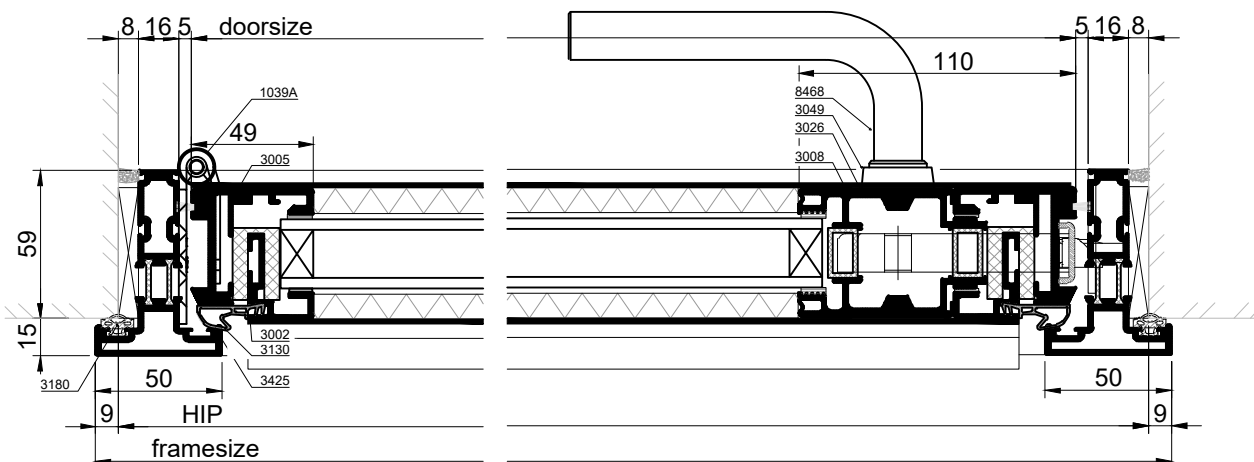
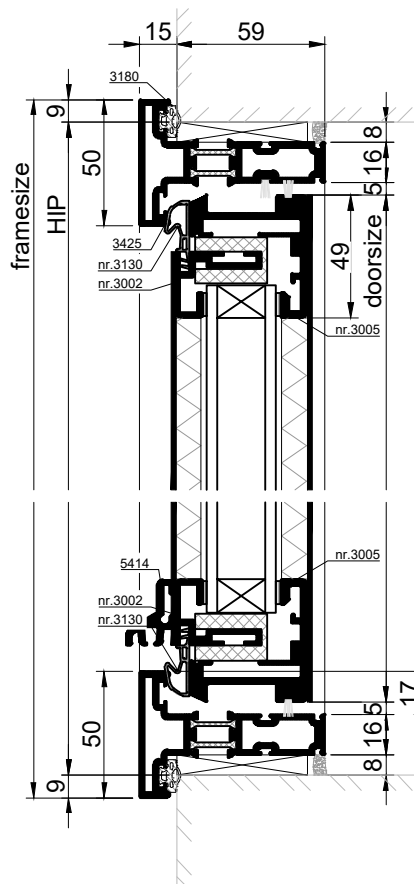
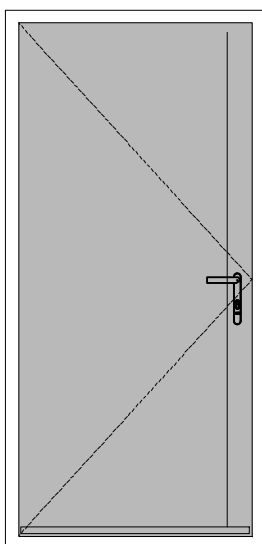

Metaglas XL outward opening door, type **XUD-1A**.

Provided with:

- Energy efficient double-glazing.

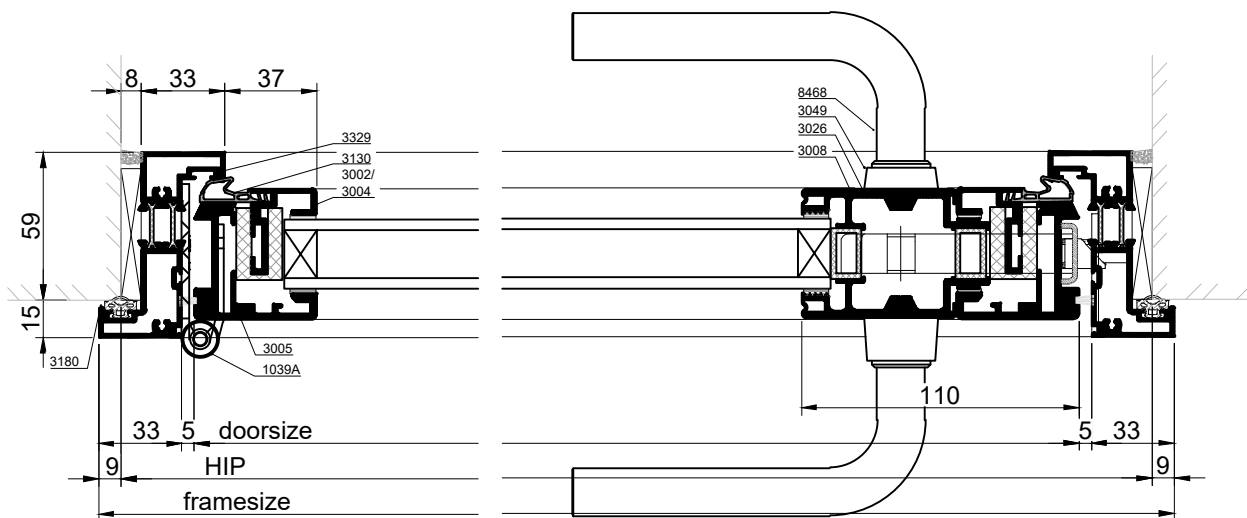
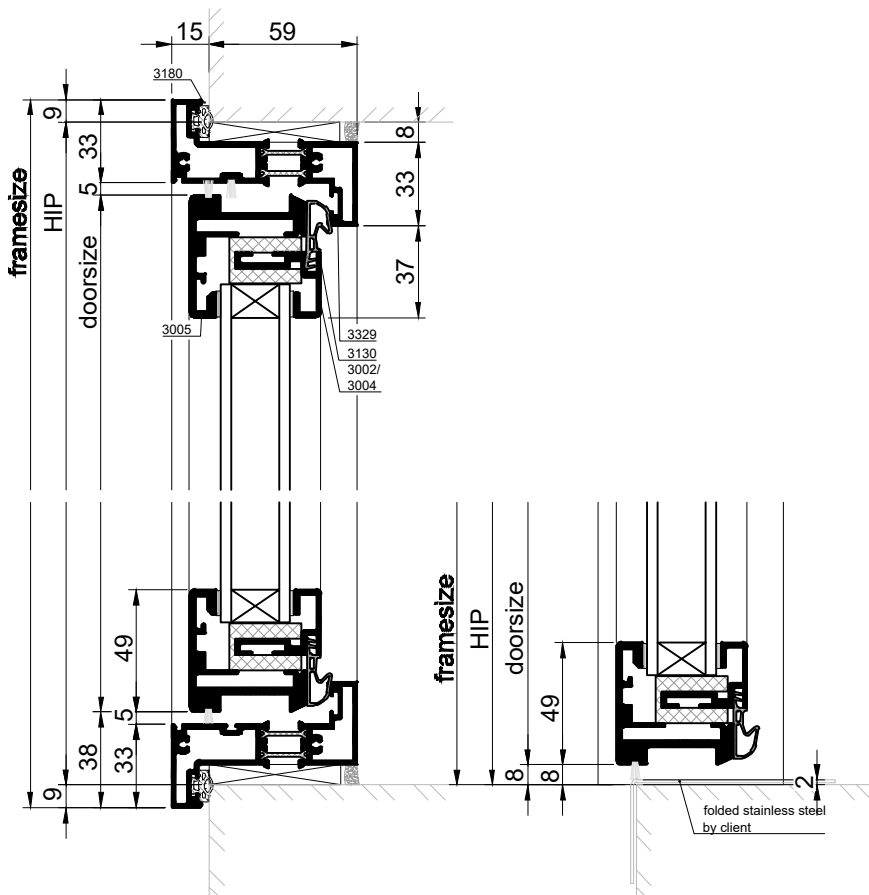
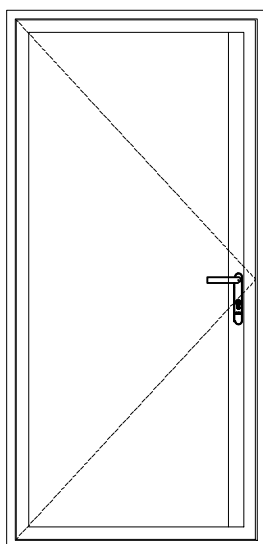

## **PARTS: WINDOW & DOOR**

All window frame handles and hinges are made of uncoloured stainless steel.